

MITICA

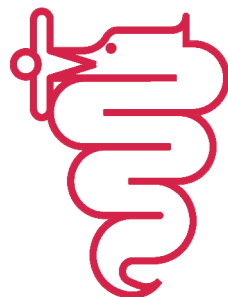

BEZZERA

Dal 1901

COD. 9942050.04

REV.02

TABLE 1 Mod. S - TOP

POS	CODE	DESCRIPTION
1	5074469SG	GROUP FRONTAL (up to 23.02.16)
1	5074469.01SG	GROUP FRONTAL (from 24.02.16)
1	5074470SG	GROUP FRONTAL . TOP version (up to 23.02.16)
1	5074470.01SG	GROUP FRONTAL. TOP version (from 24.02.16)
2	7816002	SCREW TCEI M4X12
3	7474217	ADHESIVE FEET
4	5074616LW	CUPS-HEATER GRID BZ07 BA
5	5961602.01	ASSEMBLY CUPS-HEATER
6	5344025.01	BODY STAINLESS STEEL POLISHED
7	7809804	PLAIN WASHER D4
8	7474218	FOOT
9	5340003.05LL	CHASSIS BLACK (tank version)
9	5340011LL	CHASSIS BLACK (TOP version)
10	5074617LW	DRIP TRAY GRID STAINLESS STEEL POLISHED
11	5340503DL	DRIP TRAY STAINLESS STEEL POLISHED

TABLE 1 Mod. S - TOP

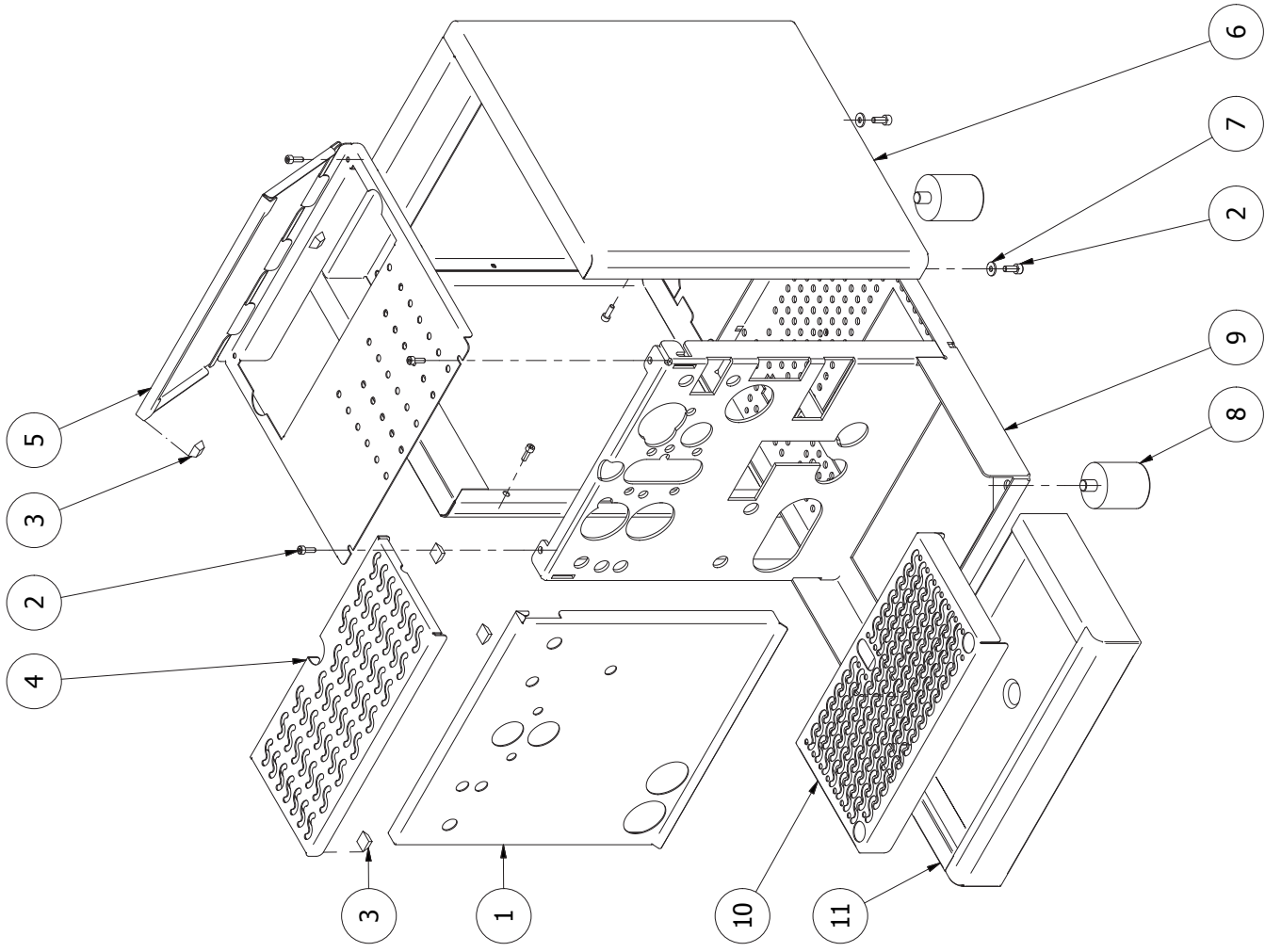

TABLE 2 Mod. S

POS	CODE	DESCRIPTION
1	7373006.03	TANK
2	7496073.01	OR GASKET 115 EP856
3	5471509	BALL 7/32" AISI 304
4	5302065	REDUCTION GEAR 1/4"G X M10
5	7374002	FILTER 1/4"G H43.5 PLASTIC
6	5471521.01	COUPLING SPRING
7	7812601	NUT M4 STAINLESS STEEL
8	7374004	WASHER D4 NYLON
9	7819908	SCREW TTEIM4X8
10	5224617	GASKET-HOLDER D14.5
11	7496076	OR GASKET 112 EPDM
12	5224414	RUBBER-HOLDER
13	5194540	HOSE 8X5 L=300 SILICONE
14	5221830	NUT M20 H5 OT
15	5225228	FITTING M20X1,25
16	7826206	SCREW TCI M3X30 OT
17	5225246	FITTING 1/8"G CONIC
18	5471535	TANK SPRING
19	7400902	PUMP PRESSURE GAUGE CAPILLARY
20	7432523	PRESSURE GAUGE D40 16BAR
21	5162237.01LL	BOILER LOAD HOSE
22	5194590	HOSE
23	5301504TR	UNION ELBOW 1/8"G X M12
24	7701111	SOLENOID VALVE 2 WAY 115V PARKER
24	7702310	SOLENOID VALVE 2 WAY 230V PARKER
24	7702409	SOLENOID VALVE 2 WAY 240V PARKER
25	7630327	SOLENOID VALVE COIL 110V PARKER
25	7630328	SOLENOID VALVE COIL 220/230V PARKER
25	7630329	SOLENOID VALVE COIL 240V PARKER
26	5221844	NUT 1/8"G H3
27	7304001TR	UNION 1/8"G
28	7303034TR	UNION ELBOW 1/8"G OT
29	7303036TR	STRAIGHT FITTING 1/8"G OT
30	7731018	VIBRATION PUMP EX5 100V C/OR
30	7731019	VIBRATION PUMP EX5 120V WITH OR
30	7731022	VIBRATION PUMP EX5 220V 60HZ WITH OR
30	7731020	VIBRATION PUMP EX5 230V WITH OR
30	7731021	VIBRATION PUMP EX5 240V WITH OR
31	7470602	VIBRATION-DAMPING
32	7303006	RUBBER-HOLDER FITTING
33	5194592	SURPRESSION VALVE HOSE
34	5162236.01LL	SURPRESSION VALVE - HEAT EXCHANGER HOSE
35	7611512	CLAMP
36	5194529	CRISTAL HOSE D6 X 9 L=150MM
37	7809806	SCREW TC M 3,5X8 PLASTITE
38	5963009.03	ASSEMBLY TANK SUPPORT

TABLE 2 Mod. S

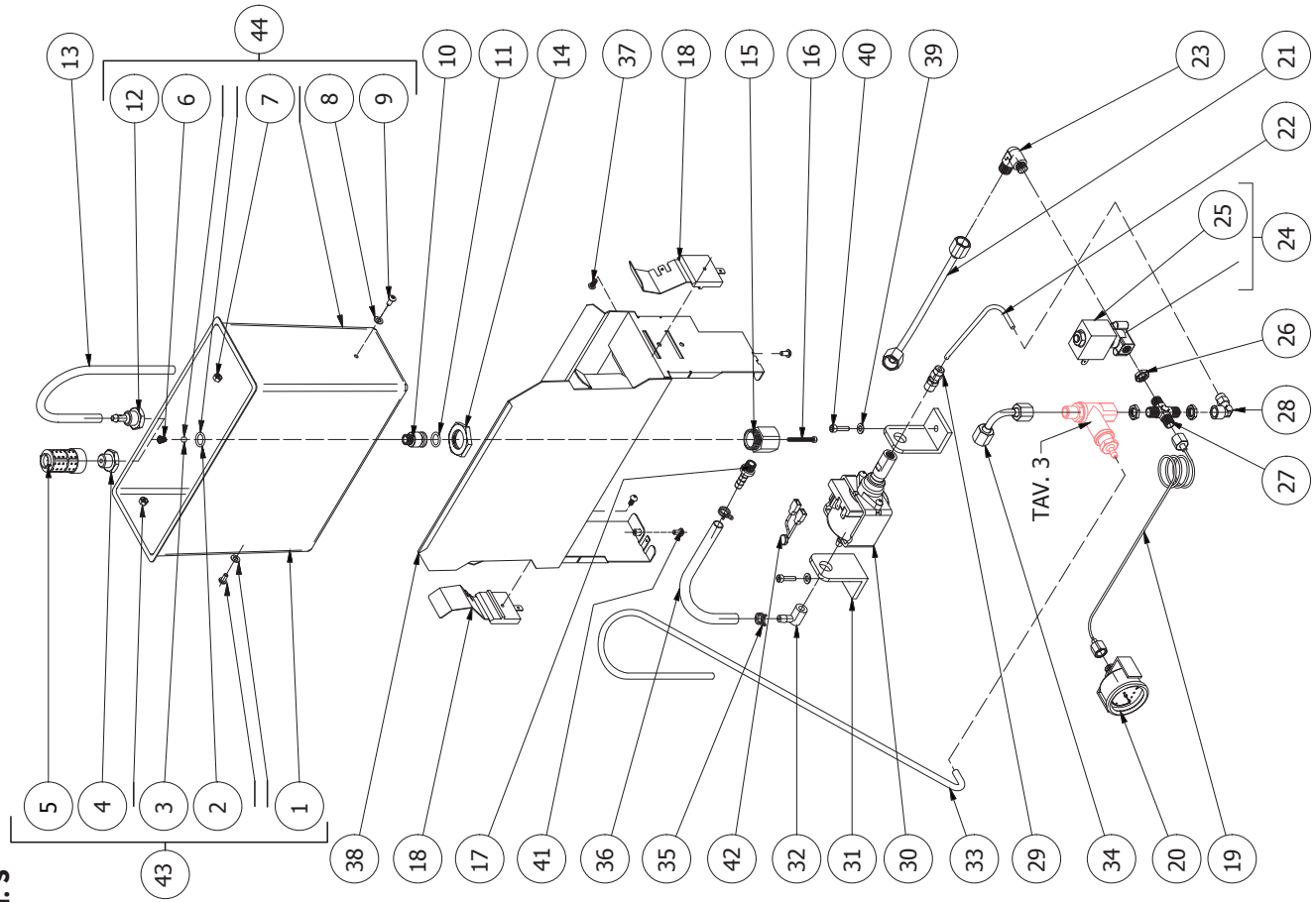

TABLE 2A (up to 20.02.13) Mod. TOP

POS	CODE	DESCRIPTION
1	5162237.01LL	BOILER LOAD HOSE
2	5301504TR	UNION ELBOW 1/8"G X M12
3	7701111	SOLENOID VALVE 2 WAY 115V PARKER
3	7702310	SOLENOID VALVE 2 WAY 230V PARKER
3	7702409	SOLENOID VALVE 2 WAY 240V PARKER
4	7630327	SOLENOID VALVE COIL 110V PARKER
4	7630328	SOLENOID VALVE COIL 220/230V PARKER
4	7630329	SOLENOID VALVE COIL 240V PARKER
5	5194508.01LL	SURPRESSION VALVE HOSE
6	5221844	NUT 1/8"G H3
7	7815001	WASHER D10 UNI 6592 A2
8	5283018CM	DRAIN FITTING FOR SURPRESSION VALVE 1/8"G
9	5162236.01LL	SURPRESSION VALVE - HEAT EXCHANGER HOSE
10	5194597LL	PUMP LOAD HOSE
11	7809806	SCREW TC M 3.5X8 PLASTITE
12	7304502TR	STRAIGHT FITTING 1/8"G
13	5301519	UNION ELBOW 3/8"G
14	7200512	FLEXIBLE HOSE
15	7432523	PRESSURE GAUGE D40 16BAR
16	7304001TR	UNION 1/8"G
17	7303034TR	UNION ELBOW 1/8"G OT
18	7816001	SCREW TCEI M5X12 UNI5931 A2
19	5194601LL	HOSE
20	7303001TR	UNION ELBOW 1/8"G
21	7304505TR	FITTING 3 WAY 1/8"
22	5194617LL	HOSE
23	7304502TR	STRAIGHT FITTING 1/8"G
24	5225228	FITTING M20X1.25
25	7826206	SCREW TCI M3X30 OT
26	5302057	FITTING 1/8" X 3/8"G OT
27	5057859LW	TANK SQUARE
28	5221844	NUT 1/8"G H3
29	5471535	TANK SPRING
30	5037837LL	PUMP SQUARE
31	5963009.03	ASSEMBLY TANK SUPPORT
32	5221830	NUT M20 H5 OT
33	7496076	OR GASKET 112 EPDM
34	5226416	PLUG
35	7730509	PUMP 50-70L/H+CLAMP+JOINT
36	7741005	ELECTRIC MOTOR 110V
36	7742404	ELECTRIC MOTOR 220/240V 50/60HZ
37	7816027	SCREW TCEI M5X8
38	5492011	GASKET D15X3
39	5221819	CAP NUT 3/8"G
40	7400902	PUMP PRESSURE GAUGE CAPILLARY
41	5471032	FILTER

TABLE 2A (up to 20.02.13) Mod. TOP

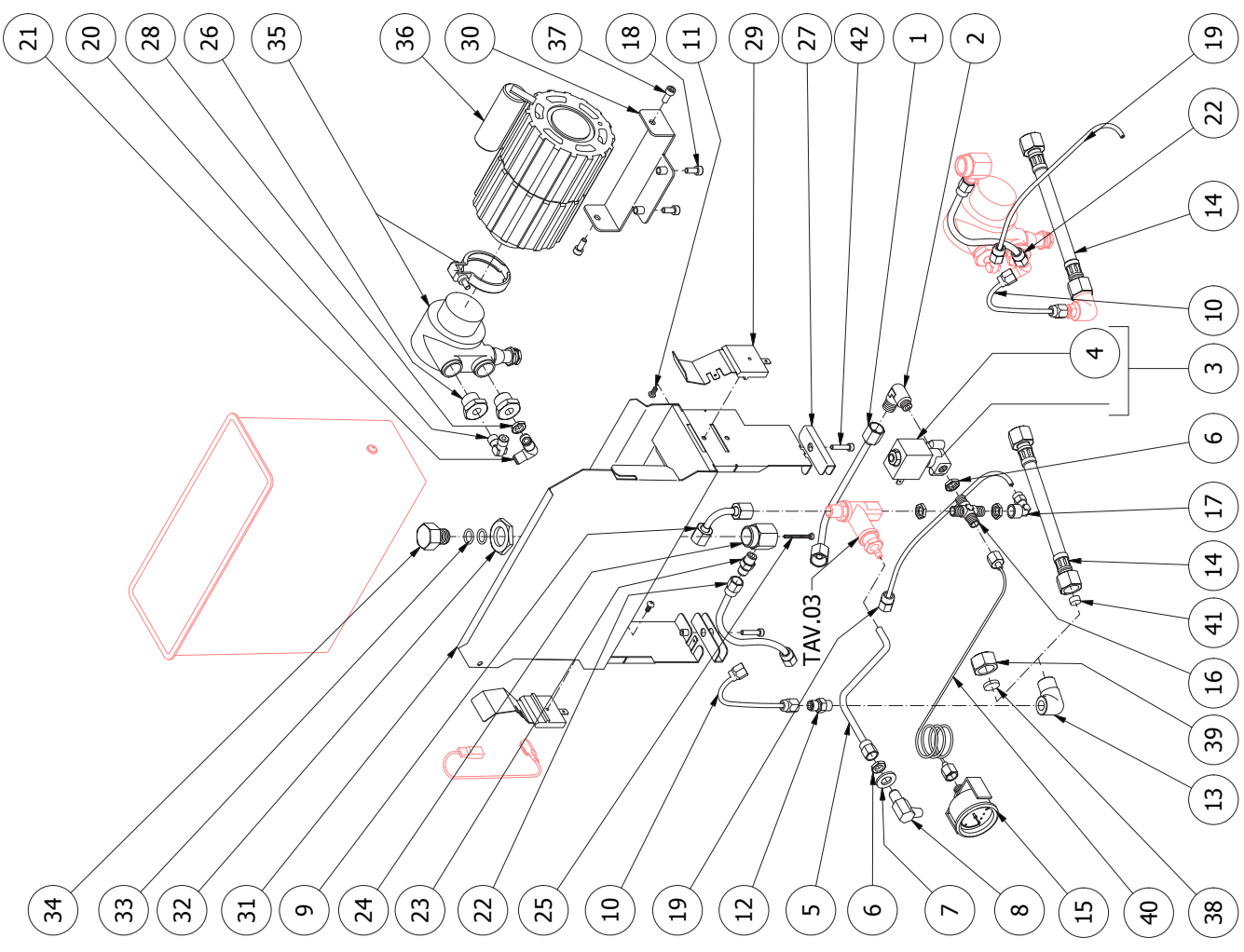
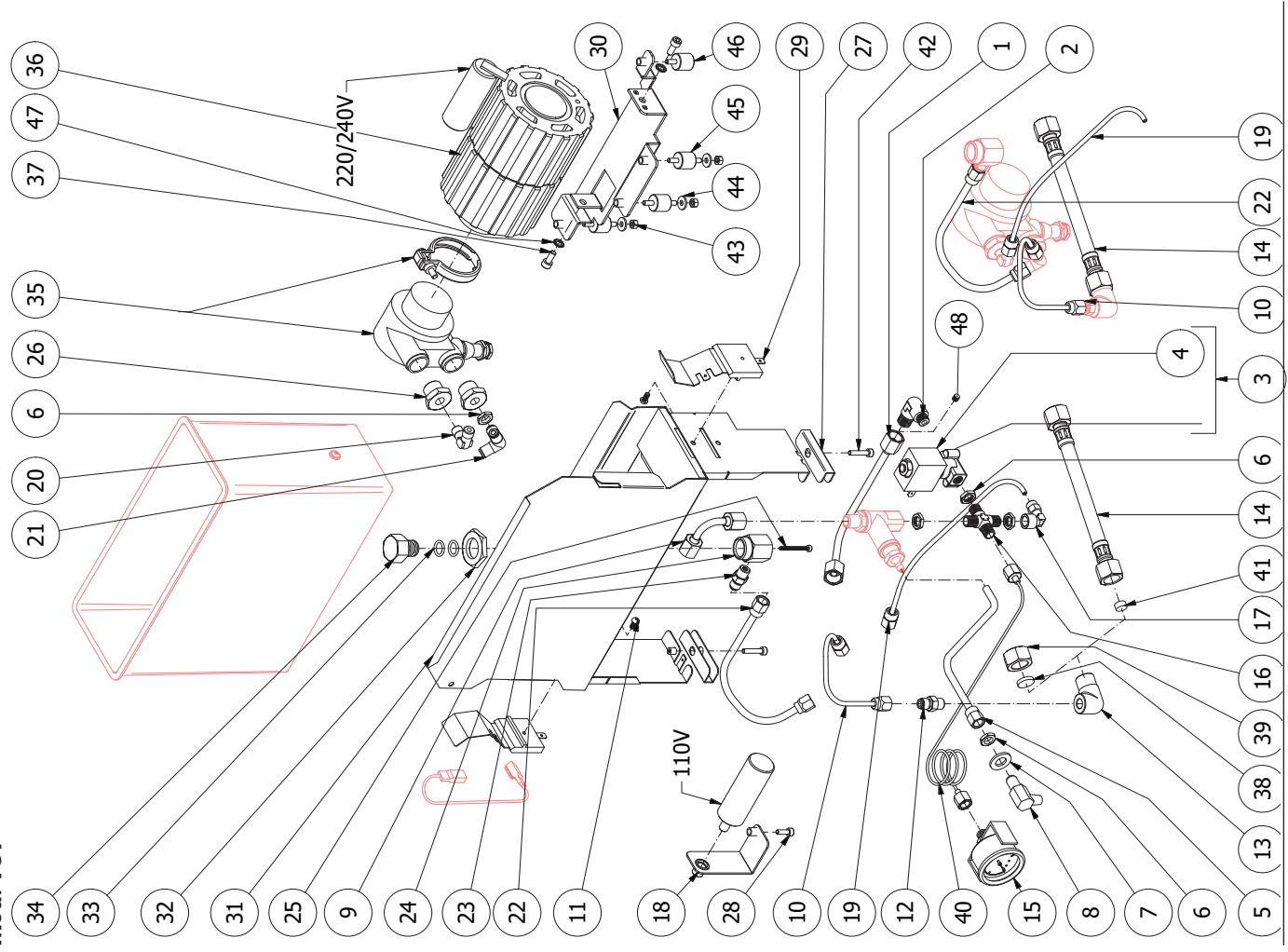

TABLE 2A (from 21.02.13) Mod. TOP

POS	CODE	DESCRIPTION
1	5162237.01LL	BOILER LOAD HOSE
2	5301504TR	UNION ELBOW 1/8"G X M12
3	7701111	SOLENOID VALVE 2 WAY 115V PARKER
3	7702310	SOLENOID VALVE 2 WAY 230V PARKER
3	7702409	SOLENOID VALVE 2 WAY 240V PARKER
4	7630327	SOLENOID VALVE COIL 110V PARKER
4	7630328	SOLENOID VALVE COIL 220/230V PARKER
4	7630329	SOLENOID VALVE COIL 240V PARKER
5	5194508.01LL	SURPRESSION VALVE HOSE
6	5221844	NUT 1/8"G H3
7	7815001	WASHER D10 UNI 6592 A2
8	5283018CM	DRAIN FITTING FOR SURPRESSION VALVE 1/8"G
9	5162236.01LL	SURPRESSION VALVE - HEAT EXCHANGER HOSE
10	5194597LL	PUMP LOAD HOSE
11	7809806	SCREW TC M 3,5X8 PLASTITE
12	7304502TR	STRAIGHT FITTING 1/8"G
13	5301519	UNION ELBOW 3/8"G(up to 15.01.15)
13	7304507TR	UNION ELBOW 1/8"G(from 16.01.15)
14	7200512	FLEXIBLE HOSE 3/8"G(up to 15.01.15)
14	7200514	FLEXIBLE HOSE 3/8"Gx1/8"G(from 15.01.15)
15	7432523	PRESSURE GAUGE D40 16BAR
16	7304001TR	UNION 1/8"G
17	7303034TR	UNION ELBOW 1/8"G OT
18	5037842LL	BRACKET (only 110V versions)
19	5194601LL	HOSE
20	7303001TR	UNION ELBOW 1/8"G
21	7304505TR	FITTING 3 WAY 1/8"
22	5194617LL	HOSE
23	7304502TR	STRAIGHT FITTING 1/8"G
24	5225228	FITTING M20X1.25
25	7826206	SCREW TCI M3X30 OT
26	5302057	FITTING 1/8" X 3/8"G OT
27	5057859LW	TANK SQUARE
28	7816002	SCREW TCEI M4X12
29	5471535	TANK SPRING
30	5037837.01LL	PUMP SQUARE
31	5963009.03	ASSEMBLY TANK SUPPORT
32	5221830	NUT M20 H5 OT
33	7496076	OR GASKET 112 EPDM
34	5226416	PLUG
35	7730509	PUMP 50-70L/H+CLAMP+JOINT
36	7741005	ELECTRIC MOTOR 110V
36	7742404	ELECTRIC MOTOR 220/240V 50/60HZ
37	7816027	SCREW TCEI M5X8
38	5492011	GASKET D15X3(up to 15.01.15)
38	5492018	GASKET D8x2 ASBETOS FREE(from 16.01.15)

TABLE 2A (from 21.02.13) Mod. TOP



POS	CODE	DESCRIPTION
1	5223003	JET M6 X 6 HOLE D0.8 OT
2	5221844	NUT 1/8"G H3
3	7815001	WASHER D10 UNI 6592 A2
4	5283018CM	DRAIN FITTING FOR SURPRESSION VALVE 1/8"G
5	5302032	STRAIGHT FITTING 1/8"G X 3/8"NPT ES.22 H27 OT
6	7611508	PUMP CLAMP
7	7472401	PUMP JOINT
8	7374005	PUMP FILTER
9	7496048	OR GASKET FOR PUMP FILTER
10	7730506	PUMP 100 L/H PA104X 1-2GR
11	7741102	ELECTRIC MOTOR 110V 18MF
11	7742206	ELECTRIC MOTOR 220/240V 10MF
12	7479976	BRACKET MOTOR
13	5038420LL	MOTOR SUPPORT
14	7613001	FAIRLEAD P36 RUBBER
15	7802403	NUT M6 UNI 7473
16	7804002	FAN WASHER D6 DIN 6798A
17	7816422	SCREW TE M6X14 UNI 5739 OT
18	7816005	SCREW TCEI M4X20
24	7701111	SOLENOID VALVE 2 WAY 115V PARKER
24	7702310	SOLENOID VALVE 2 WAY 230V PARKER
24	7702409	SOLENOID VALVE 2 WAY 240V PARKER
25	7630327	SOLENOID VALVE COIL 110V PARKER
25	7630328	SOLENOID VALVE COIL 220/230V PARKER
25	7630329	SOLENOID VALVE COIL 240V PARKER
26	5301504TR	UNION ELBOW 1/8"G X M12
27	7303034TR	UNION ELBOW 1/8"G OT
28	7304001TR	UNION 1/8"G
29	5221844	NUT 1/8"G H3
30	5194592	SURPRESSION VALVE HOSE
31	5162237.01LL	BOILER LOAD HOSE
32	5162236.01LL	SURPRESSION VALVE - HEAT EXCHANGER HOSE
33	5194574.01LL	PUMP-SOLENOID VALVE HOSE
34	7200514	FLEXIBLE HOSE 3/8"X1/8" l=1500MM
35	7613004	FAIRLEAD
36	7432523	PRESSURE GAUGE D40 16BAR
37	7400902	PUMP PRESSURE GAUGE CAPILLARY
38	7802402	NUT M4 UNI 7473

**TABLE 2B (up to 01.03.13)
Mod. R**

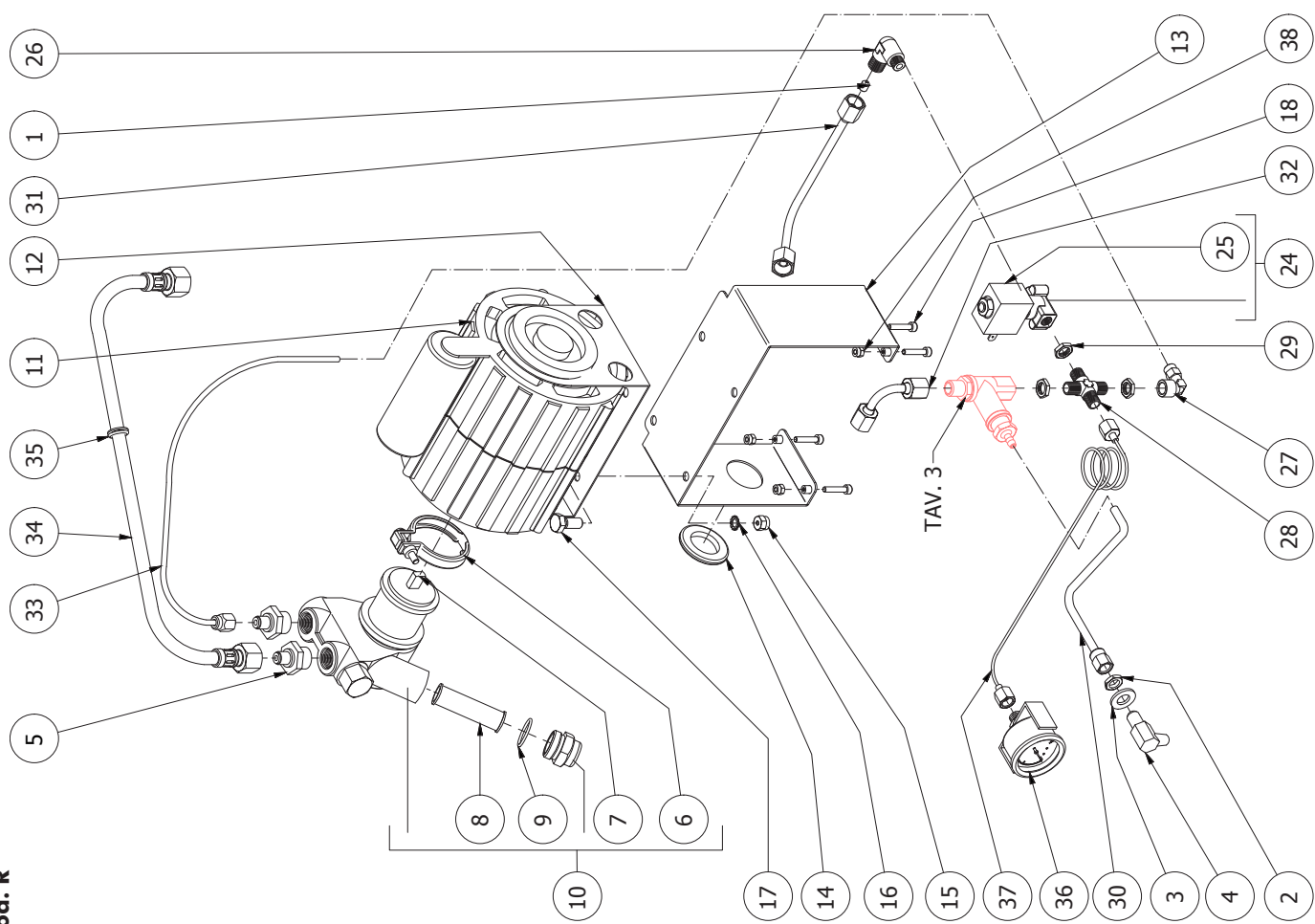

POS	CODE	DESCRIPTION
1	5223003	JET M6 X 6 HOLE D0.8 OT
2	5221844	NUT 1/8"G H3
3	7815001	WASHER D10 UNI 6592 A2
4	5283018CM	DRAIN FITTING FOR SURPRESSION VALVE 1/8"G
5	5302023	STRAIGHT FITTING 1/8"G X 3/8"G
6	7611508	PUMP CLAMP
7	7730509	PUMP 50-70L/H+CLAMP+JOINT
8	7741005	ELECTRIC MOTOR 110V
8	7742404	ELECTRIC MOTOR 220/240V 50/60HZ
9	7816027	SCREW TCEI M5X8
10	7814002	NOTCHED WASHER D5 DIN 6798A A2
11	5037837.01LL	PUMP SQUARE
12	7474219	FOOT
13	7470604	VIBRATION-DAMPING
14	7809804	PLAIN WASHER D4
15	7822603	NUT M4
16	5301504TR	UNION ELBOW 1/8"G X M12
17	7630327	SOLENOID VALVE COIL 110V PARKER
17	7630328	SOLENOID VALVE COIL 220/230V PARKER
17	7630329	SOLENOID VALVE COIL 240V PARKER
18	7701111	SOLENOID VALVE 2 WAY 115V PARKER
18	7702310	SOLENOID VALVE 2 WAY 230V PARKER
18	7702409	SOLENOID VALVE 2 WAY 240V PARKER
19	7303034TR	UNION ELBOW 1/8"G OT
20	7304001TR	UNION 1/8"G
21	5194508.01LL	SURPRESSION VALVE HOSE
22	7432523	PRESSURE GAUGE D40 16BAR
23	7400902	PUMP PRESSURE GAUGE CAPILLARY
24	5194574.01LL	PUMP-SOLENOID VALVE HOSE
25	5162236.01LL	SURPRESSION VALVE - HEAT EXCHANGER HOSE
26	5162237.01LL	BOILER LOAD HOSE
27	7200514	FLEXIBLE HOSE 3/8"X1/8" l=1500MM
28	7613004	FAIRLEAD
29	5037842LL	BRACKET (only 110V versions)

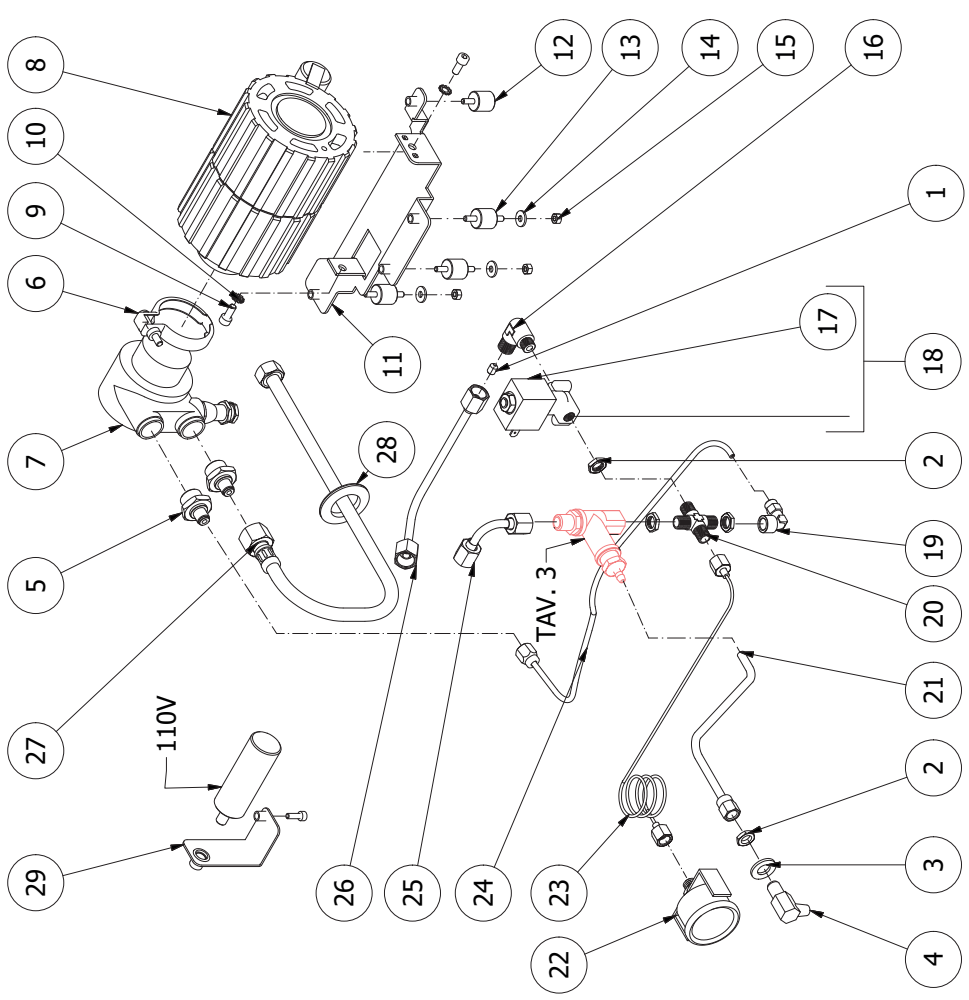

POS	CODE	DESCRIPTION
1	5302017TP	STRAIGHT FITTING M12
2	5471505	CALIBRATED SPRING D0.45
3	5224615TP	GASKET-HOLDER
4	7496018	GASKET OR 105
5	5283049	SURPRESSION VALVE BODY
6	5493001	GASKET D8 X 4 EPT
7	5224619TP	GASKET-HOLDER
8	5471506.01	CALIBRATED SPRING D1.1
9	7496052	OR GASKET 114
10	5302072	RUBBER-HOLDER FITTING
11	5965165	ASSEMBLY SURPRESSION VALVE

TABLE 3 (up to 30.10.12)

TABLE 3 (up to 30.10.12)

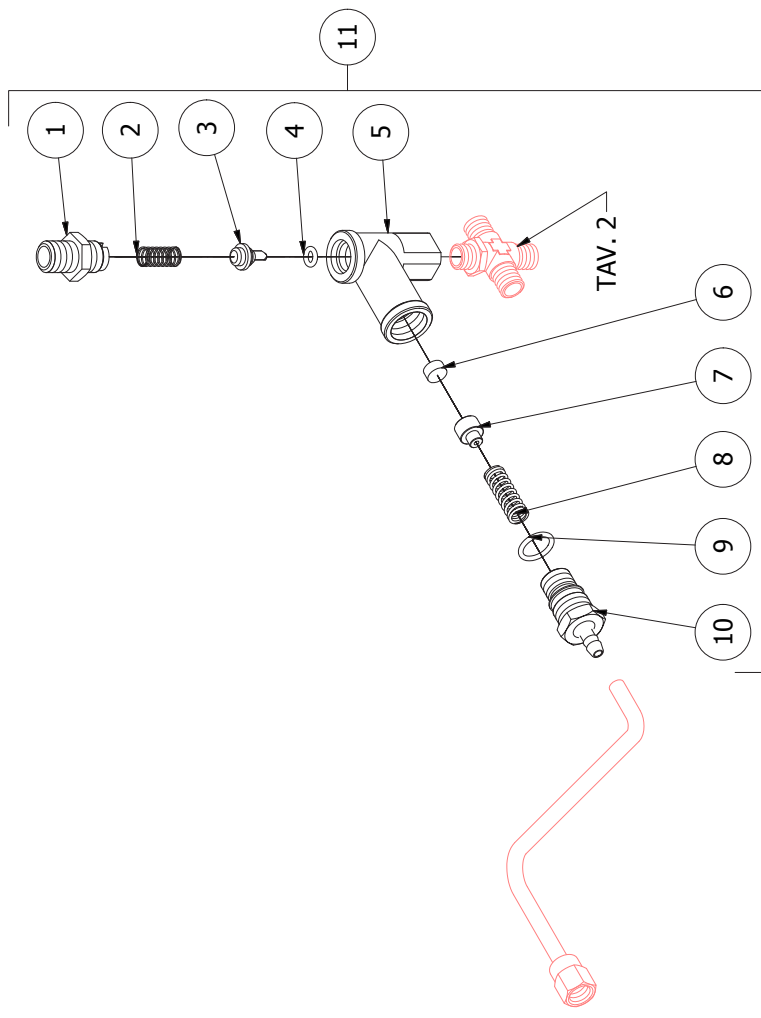

POS	CODE	DESCRIPTION
TABLE 3 (from 31.10.12)		
1	5302077TP	RUBBER-HOLDER FITTING
2	5471539	CALIBRATED SPRING D.1,6
3	7496052	OR GASKET 114
4	5224620TP	GASKET-HOLDER
5	7496018	OR GASKET 105 VITON
6	5283053TP	SURPRESSION VALVE BODY
7	5224615TP	GASKET-HOLDER
8	5471505	CALIBRATED SPRING D0.45 H22 AISI 302
9	5302017TP	STRAIGHT FITTING M12 H26.5 OT
10	5965212.01AL	ASSEMBLY SURPRESSION VALVE 12BAR
11	5493042	GASKET D.11X3
12	5471019	INOX WIRE FILTER D8,5X5 AISI304

TABLE 3 (from 31.10.12)

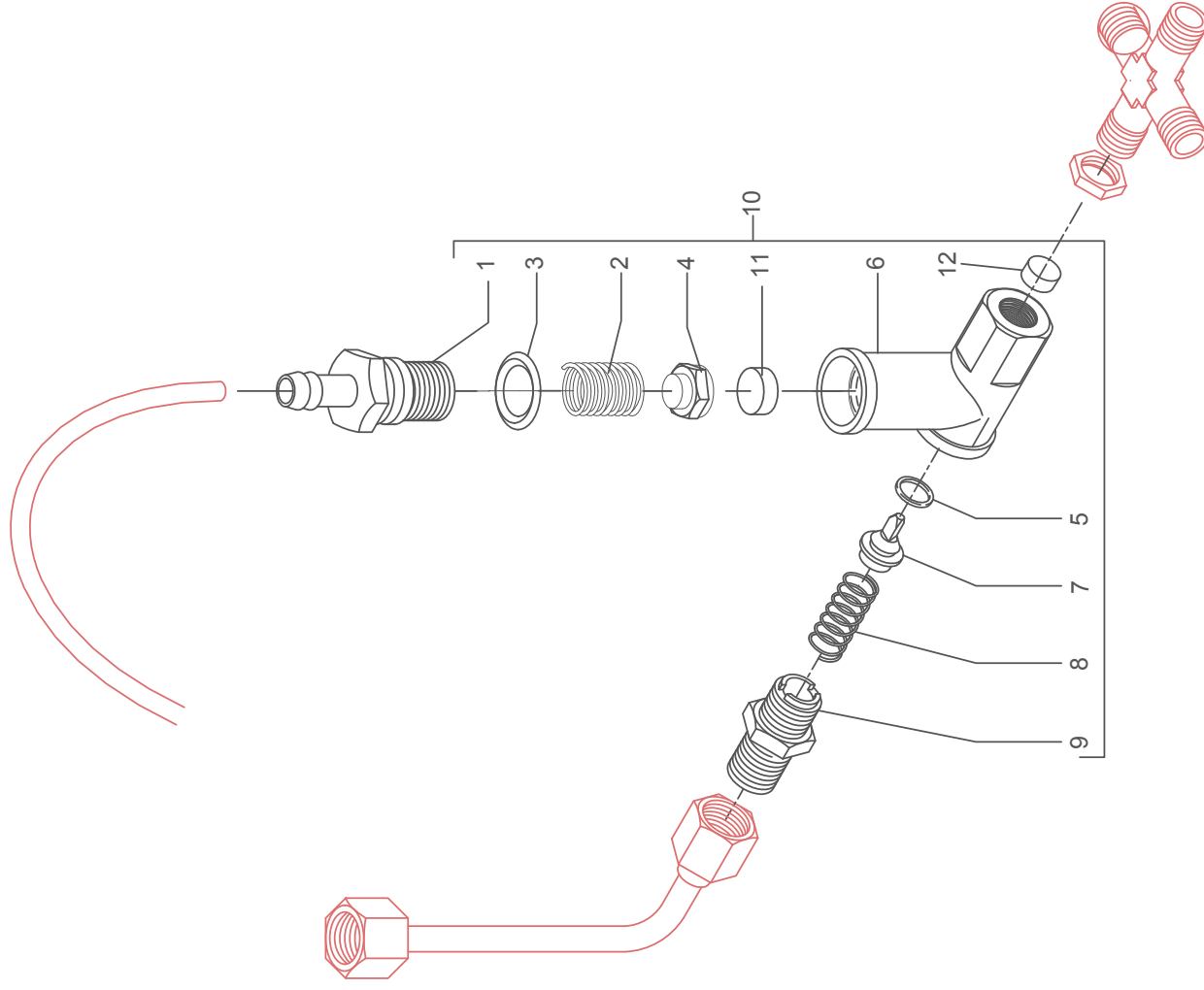

TABLE 4

POS	CODE	DESCRIPTION
1	7432522	PRESSURE GAUGE D40 3BAR
2	7400901	PRESSURE GAUGE CAPILLARY
3	5162234LL	STEAM TAP HOSE
3	5162395LL	STEAM TAP HOSE (PID version)
4	5302005	STRAIGHT FITTING 3/8" G X M13
4	5225412	FITTING (PID version)
5	5265819	LEVEL PROBE D3 X 80 X 6.3
6	5265812	MINIMUM LEVEL PROBE D3 X 110 X 4.8
7	5225205	STRAIGHT FITTING M10 OT
8	5192001	PROBE SHEATH D8 X 45 HOLE D3 PTFE
9	7452511	VALVE
10	5301521TR	UNION ELBOW 1/8" X 3/8"
11	5162239.01LL	VALVE HOSE
12	7452510.02R	ASSEMBLY SAFETY VALVE (up to 28.02.11)
12	7452509.02	SAFETY VALVE (from 01.03.11)
13	5162233LL	WATER TAP HOSE
14	7433013	PRESSURE SWITCH XP/100 1/4" G
15	5162288LL	PRESSURE GAUGE HOSE (TOP version)
16	5302064	FITTING M/F M13x1 (up to 04.10.2012)
17	5301520TR	UNION ELBOW 1/8" G
18	5320501.02BL	ASSEMBLY BOILER POLISHED
19	7434009	THERMOSTAT MANUAL 16A 135°C
20	5227007	DOWEL M8 X 6 HOLE M4
21	5492008	GASKET D10.5 X 2
22	5221813	CAP NUT M12
23	5492025	GASKET D42x32x2 PTFE
24	5721127TP	HEATING ELEMENT 1350 110V
24	5722240TP	HEATING ELEMENT COPPER 220/240V - 1250/1450W
25	5163204LL	BOTTOM HEATING HOSE
26	5164067.01LL	UPPER HEATING HOSE
26	5164090LL	UPPER HEATING HOSE (only TOP version)
27	5329020DC-AL	EXCHANGER 3 HOLES
28	5495007	GASKET D32 X 3 BRASS
29	5302006TP	STRAIGHT FITTING 1/8" G X M12
30	5192301	SUCTION HOSE D6 L=130MM PTFE
31	5225413	REDUCTION GEAR 1/2" GX 3/8" G (from 01.03.11)
32	7433001	PRESSURE SWITCH 30A (TOP version from 14.03.17)
32	5963145	PRESS. SWITCH 30A KIT (TOP version up to 13.03.17)
33	5162235LL	PRESSURE GAUGE HOSE
34	5227002	SCREW M8 X 6 OT

TABLE 4

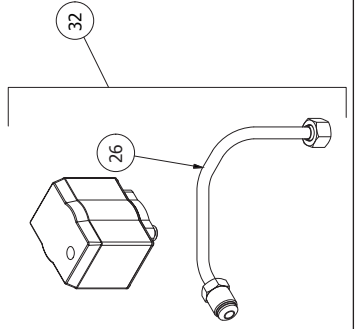
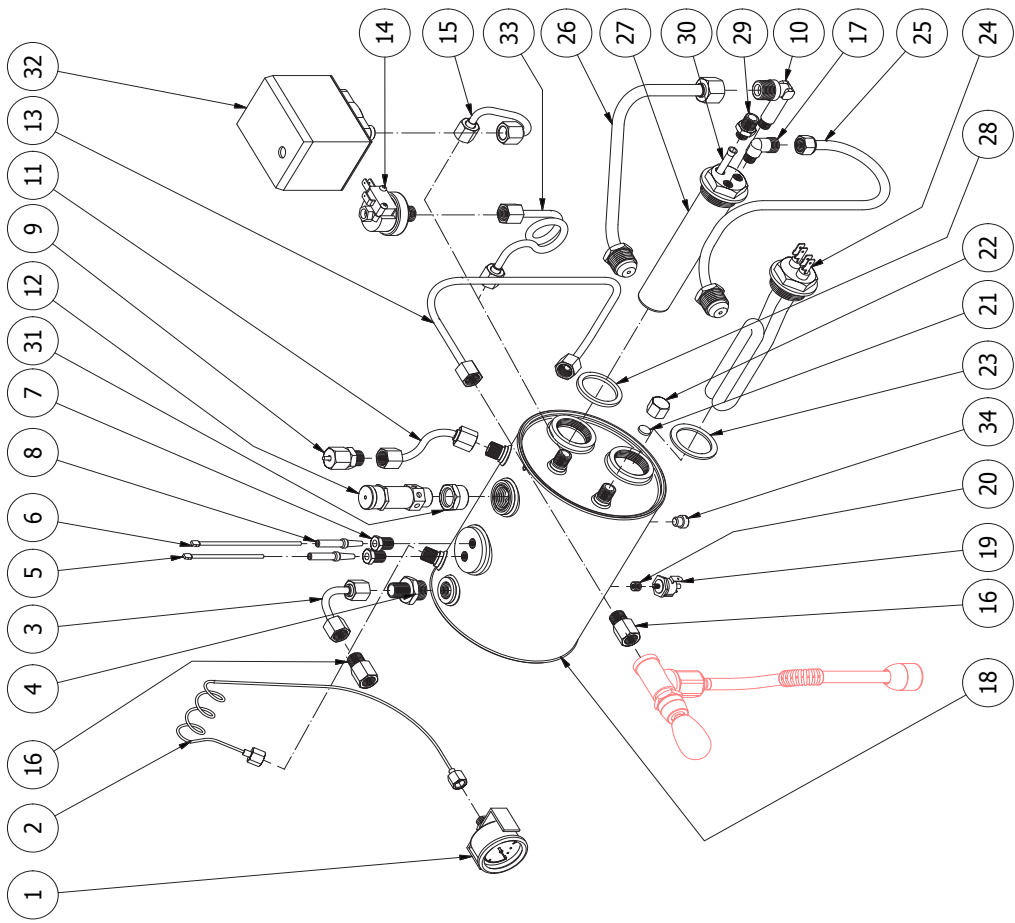

TABLE 5

POS	CODE	DESCRIPTION
1	7479952	UPPER ASSY PLUG
2	7479953	GASKET TF 22X17X2
3	7479954	INOX FILTER Ø8.5X22
4	7479955	INJECTOR M6X0.75 FORO Ø0.7
5	7479956	UPPER SLEEVE ASSY
6	7479933	INJECTOR Ø0.7 UPPER SLEEVE ASSY
7	7479934	GASKET OR 128 VITON
8	7479935	GASKET TF Ø35X30X2
9	7479936	DELIVERY VALVE SPRING
10	7479937	DELIVERY VALVE ASSY
11	7479940	DELIVERY GROUP BODY
12	7493011	INSULATING
13	5267013	TIE ROD M8 X 31 ASTM A193
14	7812607	NUT M8 UNI 5887 ASTM A194
15	7479938	GASKET TF Ø10X6X1
16	7479939	SCREW TCE M6X8
17	7479951	CAM STOP PIN
18	7479950	CAM SHAFT
19	7479949	CAM FLANGE ASSY
20	7371511.01	LEVER KNOB
21	7479931	DELIVERY LEVER
22	7479947	WASHER Ø8
23	7479948	CAP Ø15XM6
24	7479946	ASSEMBLY VALVE
25	7479942	SPRING GUIDE BUSHING
26	7479957	LOWER SLEEVE ASSY
27	7479943	ASSEMBLY RELIEF VALVE
28	7479944	DRAIN SPRING
29	7479945	JET-BREAKER BUSHING Ø15X6
30	7479960	GASKET TF D26x21x2
31	7479961	GROUP BOTTOM FITTING
32	7479941	SPRAYER Ø30
33	5471022	SHOWER FILTER
34	5493039	UNDERCUP GASKET
35	7479967	CAM FLANGE
36	7479968	WASHER EP709 15.5X7,5X4
37	7479969	BUSHING
38	7479970	SPRING
39	7479971	PLUG CHROMED

TABLE 5

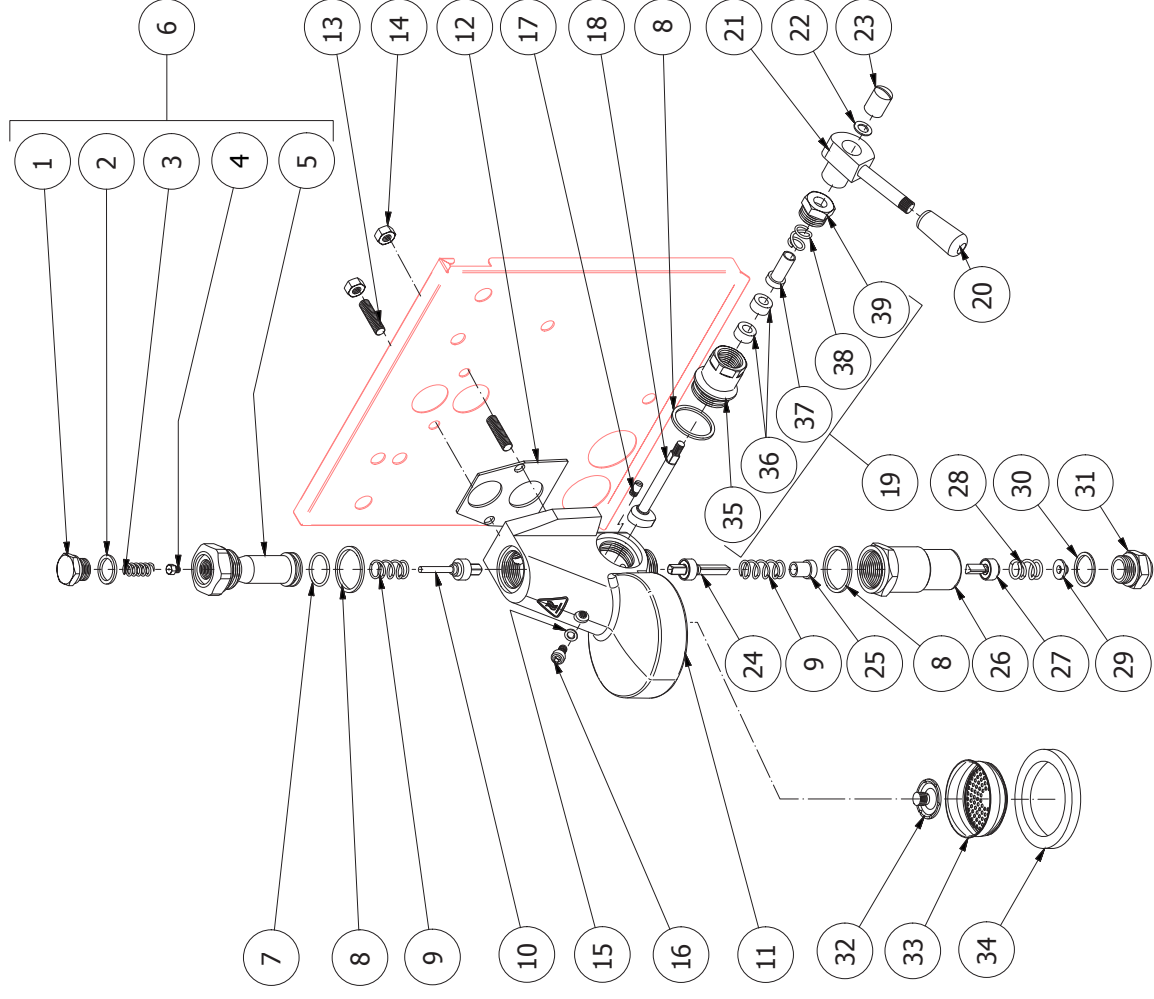

TABLE 5A (from 29.01.14)

POS	CODE	DESCRIPTION
1	7371511.01	LEVER KNOB
2	5222823CM	RING NUT 3/8"G H17
3	5221826CM	NUT 3/8"G ES.22X5
4	5225610	ARTICULATION M8 INOX
5	5260204DL	SHAFT D12X47
6	5471513	SPRING
7	5261801	WASHER D11
8	5494004	GASKET D12 X 6 PTFE GRAPHITIZED
9	5283055TW	TAP BODY OT FOR OR
10	5496042	GASKET D11X4X4 EPT 70 (C6)
11	5224603TP	GASKET-HOLDER
12	5964085.01AL	ASSEMBLY TAP WITH OR
13	7496052	OR GASKET 114
14	5225417TP	FITTING M14XM13 WHIT OR
15	7496072	OR GASKET 121
16	5471532	SPRING
17	5190501	COMPLETE CUP
18	5494017	ARTICULATION GASKET
19	5221872TW	NUT 3/8"G
20	7371003	INSULATING
21	7496084	GASKET
22	7479985.01TW	ASSEMBLY WATER HOSE
23	7496084	GASKET
24	7305014	TERMINAL 2 HOLES
25	7479990.01TW	ASSEMBLY STEAM HOSE TERMINAL 2 HOLES
26	5225608	ARTICULATION M8 INOX
27	5260203DL	SHAFT D12X47
28	5964084.01AL	ASSEMBLY TAP WITH OR

TABLE 5A (from 29.01.14)

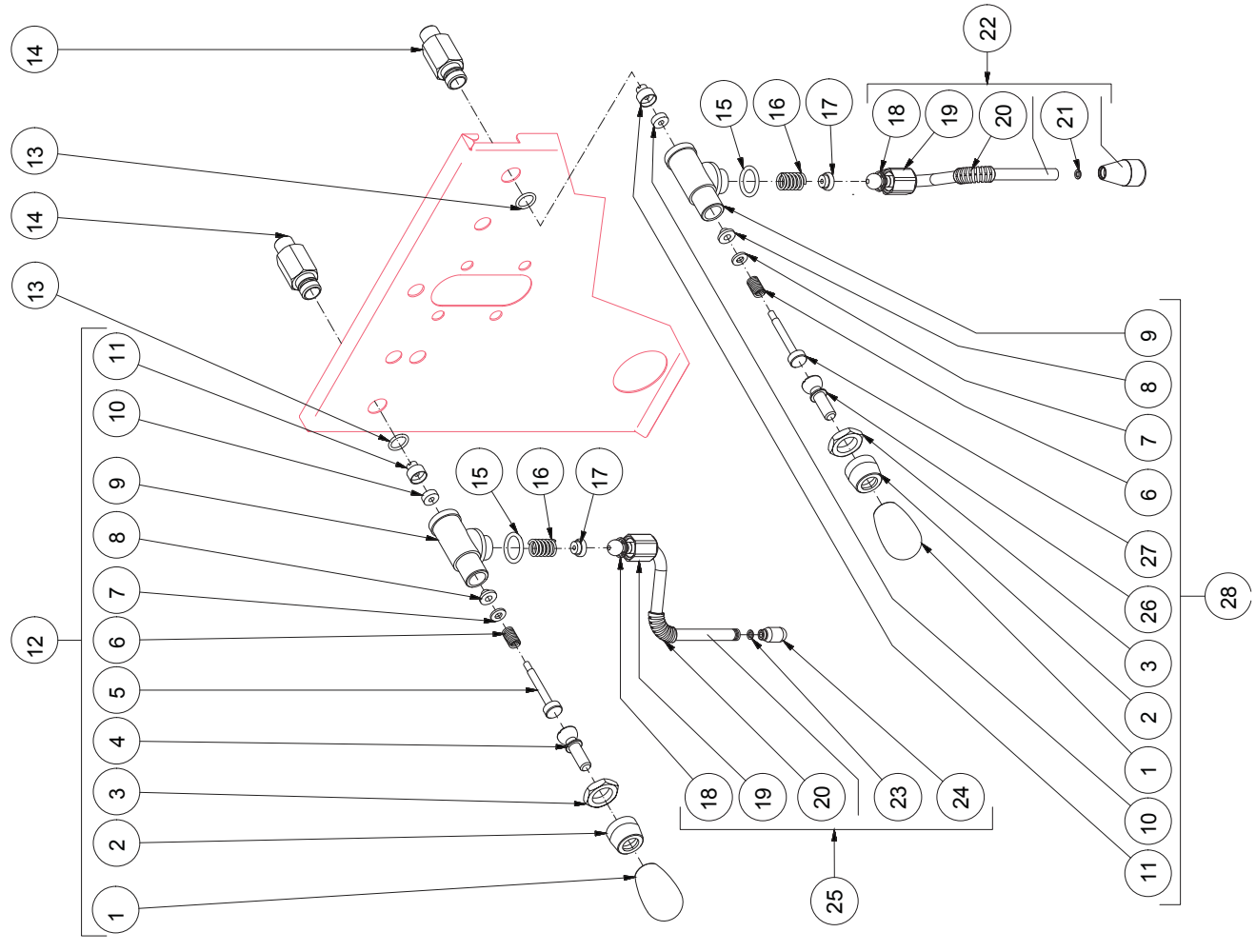
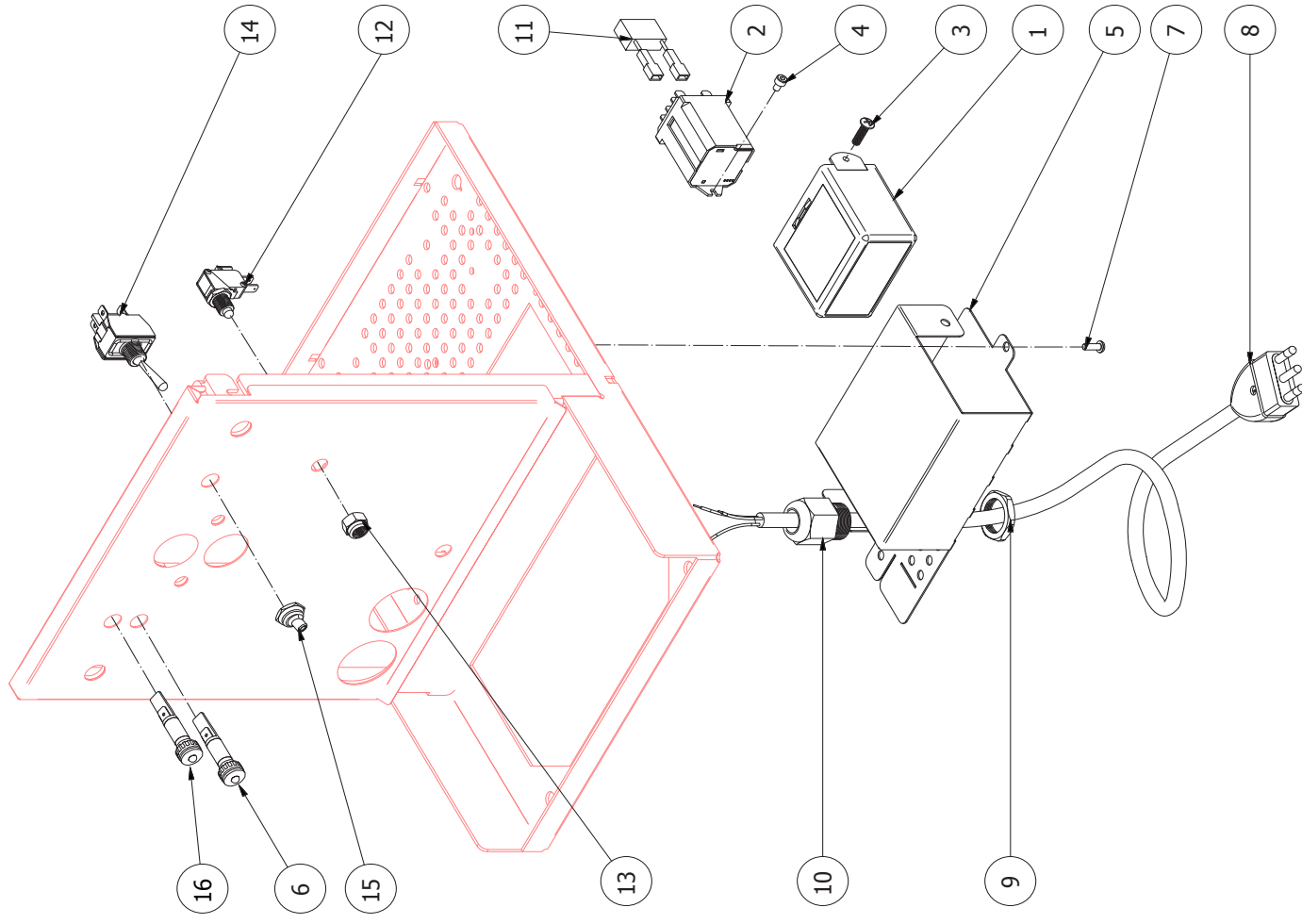

TABLE 6 (from 01.12.15)

POS	CODE	DESCRIPTION
1	7661033.02PR	LEVEL REGULATOR 3 PROBES 110/120V
1	7661043.01PR	LEVEL REGULATOR 3 PROBES 220/240V
2	7635418	RELAY 16A 110V
2	7635419	RELAY 16A 230V
2	7635420	RELAY 16A 240V
2	7635403	RELAY 30A 110V (only TOP version)
2	7635410	RELAY 30A 220/230V (only TOP version)
2	7635401	RELAY 30A 240V (only TOP version)
3	7819404	TAPPING SCREW TPS D4.8X16
4	7816017	SCREW TCEI M4X6
5	5035709.02LL	ELECTRIC PARTS SUPPORT PLATE
5	5035718.01LL	ELECTRIC PARTS SUPP. PLATE (only TOP version)
6	7633625	ORANGE LAMP 110/230V
7	7819908	SCREW TTEI M4X8
8	7551001	CABLE WITH USA PLUG 125V 15A
8	7551003	CABLE WITH USA PLUG 250V 20A
8	7555001	CABLE WITH SCHUKO PLUG
8	7554001	CABLE WITH ENGLISH PLUG
8	7552001	CABLE WITH AUSTRALIAN PLUG
8	7555003	CABLE WITH SWITZERLAND PLUG
9	7614006	NUT PG13,5
10	7614007	CABLE-PRESS PG13,5
11	7663005R	FILTER RC
12	7633906	MICROSWITCH 250V
13	5221875CM	NUT M10X0,75
14	7633326	BIPOLAR SWITCH
15	7372507	SWITCH PROTECTION PLASTIC
16	7633624	GREEN LAMP 110/230V

TABLE 6 (from 01.12.15)



POS	CODE	DESCRIPTION
1	7666002	PROBE T.PID
3	5018468LW	PID SUPPORT
4	7822602	NUT M3
5	7814001	WASHER D4 DIN 6798A A2
6	7663581	CONNECTING CABLE
7	5053026LW	COVER
8	7816016	M3X6 SCREW
9	5191511	SPACER
10	5191510	SPACER
11	7665529	DISPLAY
12	7434021	THERMOSTAT THERMOPID 230/240V
13	5522076	THERMOPID PLATE
14	7633626	RED LAMP 110/230V
15	7633326	BIPOLAR SWITCH
16	7372507	SWTCH PROTECTION PLASTIC
17	7555001	CABLE WITH SCHUKO PLUG
17	7552001	CABLE WITH AUSTRALIAN PLUG
17	7555003	CABLE WITH SWITZERLAND PLUG
17	7551001	CABLE WITH USA PLUG 125V 15A
17	7551003	CABLE WITH USA PLUG 250V 20A
18	7614006	NUT PG13,5
19	7614007	CABLE-PRESS PG13,5
20	7633906	MICROSWTICH 250V
21	5221875CM	NUT M10X0,75
22	7819908	SCREW TTEI M4X8
23	7814001	WASHER D4 DIN 6798A A2
24	5035709.02LW	ELECTRIC PARTS SUPPORT PLATE
25	7819404	TAPPING SCREW TPS D4.8X16 UNI 6955 A2
26	7661033.02PR	LEVEL REGULATOR 3 PROBES 110/120V
26	7661043.01PR	LEVEL REGULATOR 3 PROBES 220/240V
27	7635424.01	RELAY SSR
28	7816017	SCREW TCEI M4X6

TABLE 6A

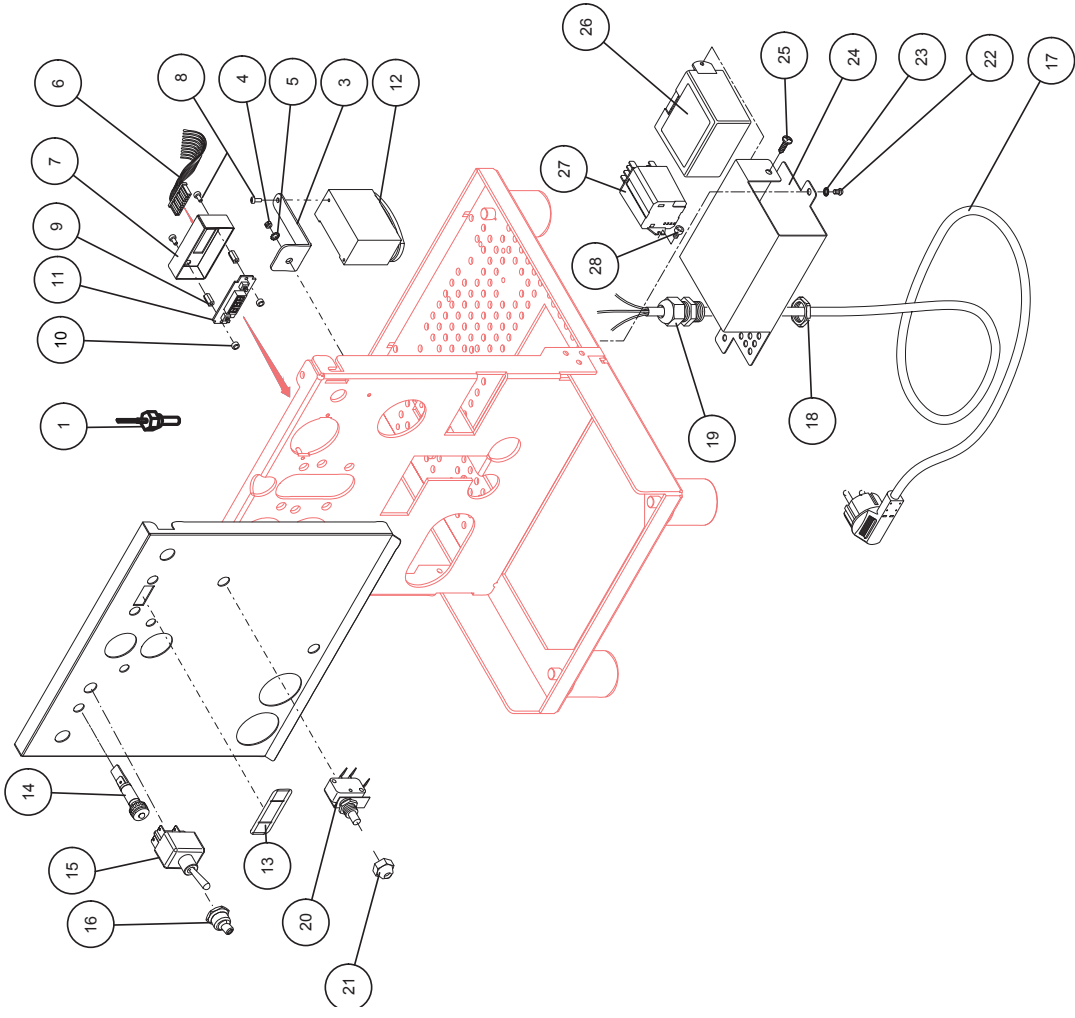

POS	CODE	DESCRIPTION
1	5372101	MEASURER
2	5373001	COFFEE-PRESS
3	7990603	CLEANING BRUSH
4	5471003	BLIND FILTER
5	5471031.01	FILTER 1 CUP 8 GRAMS WITH RUN CHANNEL
6	5471021.01	FILTER 2 CUPS 12 GRAMS WITH RUN CHANNEL
6	5471026.01	FILTER 2 CUPS 14 GRAMS WITH RUN CHANNEL
6	5471035	FILTER 2 CUPS 16 GRAMS WITH RUN CHANNEL
7	5965588.01R	ASSEMBLY COMPLETE FILTER-HOLDER 1 CUP
7	5965590.01R	ASSEMBLY COMPLETE FILTER-HOLDER 2 CUPS
8	5471527	FILTER-HOLDER SPRING D1.2 AISI 302
9	7479972.01TW	FILTER-HOLDER
10	5978508.01	KNOB
11	5371203	HANDLE
12	7816026	SCREW TCEI M12X60
13	7809806	SCREW TC M3.5X8 (up to 18.06.15)
13	7809810	SCREW TC M3.5X10 (from 19.06.15)
14	5371204	PLUG CHROMED
15	5371205	PLATE WITH LOGO
16	7305006TW	SPOUT 1 WAY
17	7305007TW	SPOUT 2 WAY
18	7493021	GASKET (from 19.06.15)

TABLE 7 (from 03.12.12)

TABLE 7 (from 03.12.12)

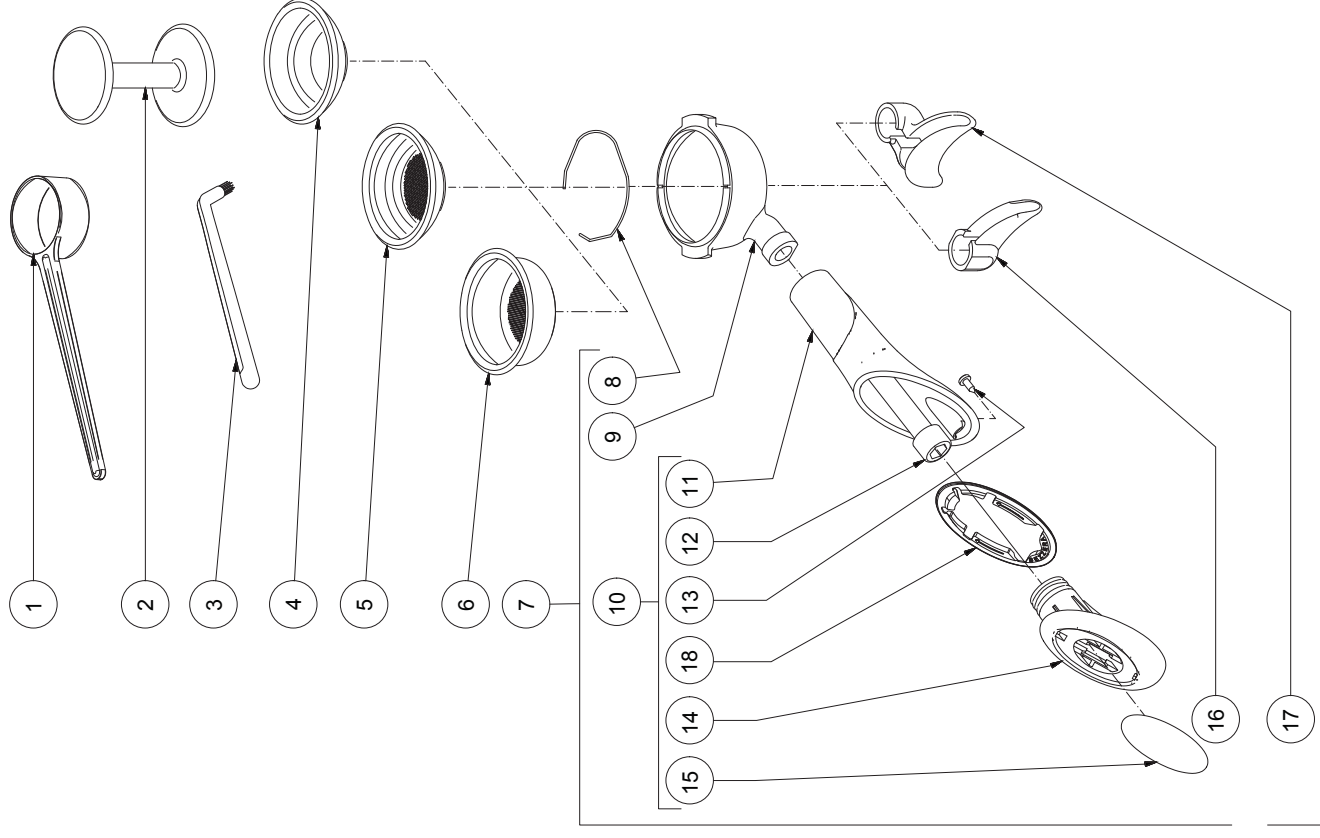

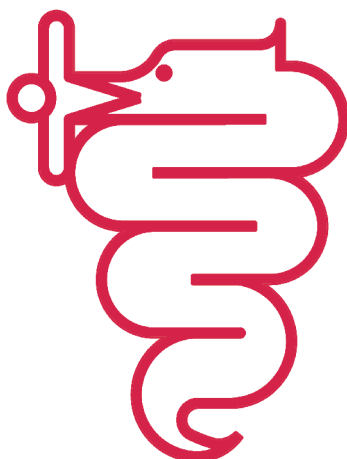

BEZZERA

Dal 1901

G.BEZZERA S.R.L.

MACCHINE PER CAFFE' ESPRESSO

Via Luigi Bezzera,1

20088 Rosate - Milano - Italy

Tel. 02 90848102 r.a. - Telefax 02 90870287

Web: www.bezzera.com

e-mail: admin@bezzera.it

Cod.9942050.04 ed.05/17 rev.02