

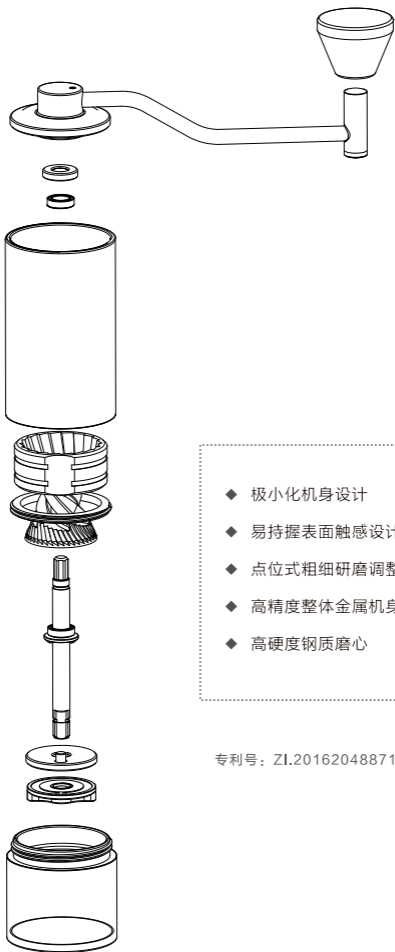

**chestnut**

栗子SILM咖啡豆研磨器

使用说明书



- ◆ 极小化机身设计
- ◆ 易持握表面触感设计
- ◆ 点位式粗细研磨调整
- ◆ 高精度整体金属机身
- ◆ 高硬度钢质磨心

专利号：ZL201620488714.6

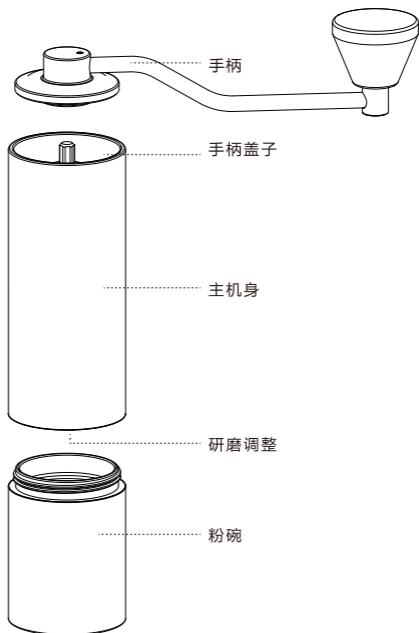

**主机身**：铝合金6063

**粉碗**：铝合金6063

**手柄摇杆**：奥氏体不锈钢17Cr18Ni9

**中轴**：奥氏体不锈钢17Cr18Ni9

**磨芯**：马氏体不锈钢20Cr13 (SLIM)

易切削结构钢11SMnPb37 (SLIMS)

## 研磨机的使用方法

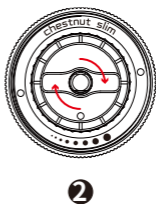
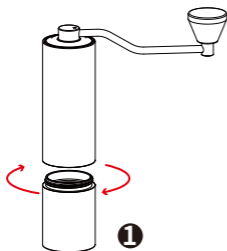

旋出粉碗，在主机身下端调整至所需的研磨粗细度

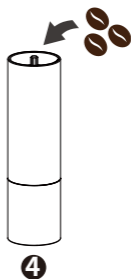
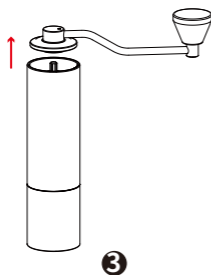

旋紧粉碗，打开上端手柄盖子，从顶端倒入咖啡豆（一次不多于20g）

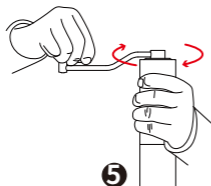

盖上盖子，一手持握另一手摇动手柄进行研磨。研磨后旋出粉碗，倒出咖啡粉。

## 研磨度的调节

此端面为研磨度调节器

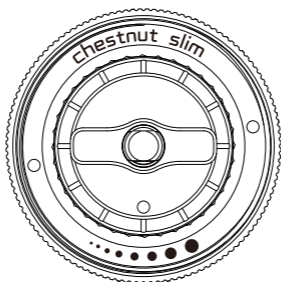

- ◆ 顺时针旋转研磨度变细，逆时针旋转研磨度变粗。
- ◆ 顺时针旋转至最细极限时手柄会无法转动，此时为原点。
- ◆ 以原点为基准，逆时针旋转N格，来调整研磨度。

不同萃取方式所需旋转格数参考下列图表。

以原点为基准

意式咖啡 6-12格

手冲咖啡 15-24格

法压壶 24格

- ◆ 研磨度表格仅为经验估值，仅供参考，请根据实际调整
- ◆ 为保护磨心，请勿在0-6格范围内研磨
- ◆ 调整研磨度时需要将手柄盖子盖上
- ◆ 逆时针转动过多会导致磨心结构被拆卸

## 注意事项

- ◆ 本设备仅为研磨烘焙后咖啡豆设计，请勿研磨其他物品。
- ◆ 建议使用毛刷对设备进行清理，请勿水洗。
- ◆ 磨芯边缘较为锋利，请注意以免划伤。
- ◆ 请勿让儿童操作本产品。
- ◆ 在背阴干燥环境下存放本产品。
- ◆ 不建议自行拆卸、更换磨心及其他内部部件，如有特殊需求，请在相关技术人员指导下进行。

## 故障排除

- ◆ **Q:研磨出现明显不均匀**  
**A:请首先确定顶端轴承螺母紧固未松脱。如松脱请逆时针紧固顶端螺母。如仍未解决，可联系我司客服处理。**
- ◆ **Q:调整研磨度时调节旋钮出现空转**  
**A:内部弹簧或者是内外磨心卡住。可尝试单手握住机身同时另一只手晃动把手，直到听到咔哒一声，此时表明弹簧或者磨芯已经弹出。如未弹出，可拧松上端轴承螺母上的挡片，拆出整个轴与磨芯，进行清理并装回。**

违反以上注意事项所导致的后果，我司不承担相应责任。

\*竖纹版栗子SLIM表面纹理由明谦咖啡提供设计支持

chestnut

泰摩栗子SILM咖啡豆研磨器

TIMEMORE CHESTNUT SILM COFFEE GRINDER

泰摩咖啡是专注于咖啡器具的原创设计品牌

以“专业+美学”的设计理念

打造有价值的咖啡器具产品

旨在让人们享受自己制作的慢生活时光

前往天猫商城 [tmall.com](http://tmall.com) / 京东商城 [jd.com](http://jd.com) 直接搜索



自己做咖啡 · 找泰摩



**chestnut**

CHESTNUT SILM COFFEE GRINDER

User Manual



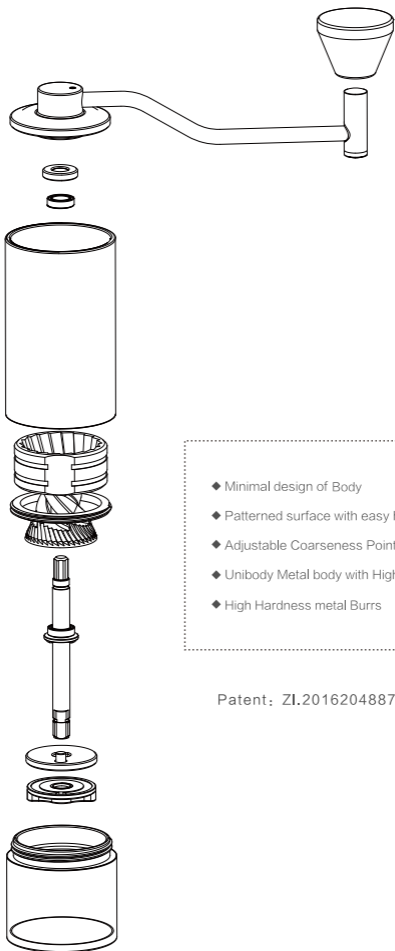

- ◆ Minimal design of Body
- ◆ Patterned surface with easy hand grip
- ◆ Adjustable Coarseness Point to Point
- ◆ Unibody Metal body with High precision
- ◆ High Hardness metal Burrs

Patent: ZI.201620488714.6

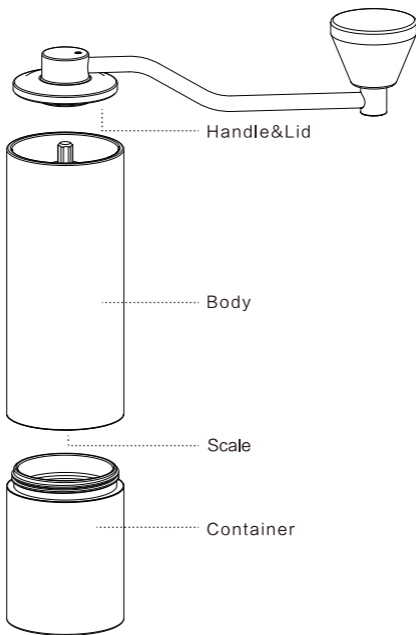

**BODY** : Aluminum Alloy 6063

**CONTAINER**: Aluminum Alloy 6063

**HANDLE**: Austenitic stainless steel 17Cr18Ni9

**CENTRAL AXLE**: Austenitic stainless steel 17Cr18Ni9

**BURRS** : **Martensitic stainless steel 20Cr13 ( SLIM )**

Free cutting structure steel 11SMnPb37 ( **SLIMS** )

# How to Grind

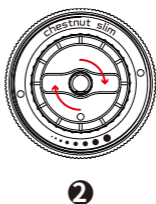
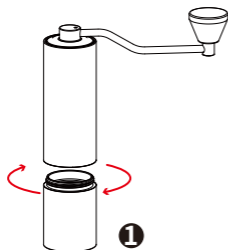

Pull out the container. Set up coarseness by turning the scale at the bottom of the body.

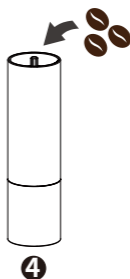
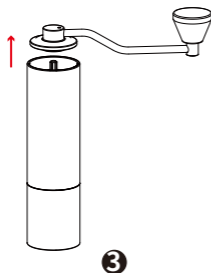

Fasten Body with the container. Then open the lid and pour coffee beans inside from the top of the grinder (less than 20g).

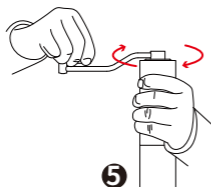

Hold the body and rotate the handle.

Pull out the container and pour the ground coffee after grind is finished.

## How to Adjust

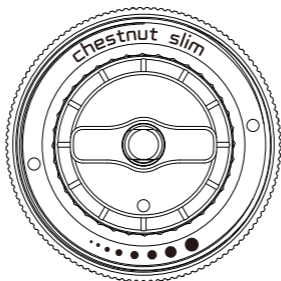

- ◆ Rotate clockwise for Finer grinding.  
Rotate anti-clockwise for coarser grinding.
- ◆ Rotate clockwise to the end, this position is called START POINT.
- ◆ You can refer to the start point to adjust the Coarseness which you prefer.

**ESPRESSO** 6–12 Clicks

**POUR OVER** 15–24 Clicks

**FRENCH PRESS** 24 Clicks

- ◆ The table above is for your reference only.
- ◆ **DO NOT try to grind coffee beans at the finest 0–6 clicks to protect the Burr sharpness.**
- ◆ Cover the lid before your adjust coarseness.

## Caution

- ◆ The device is for grinding coffee beans only. DO NOT grind other material.
- ◆ It's recommended to clean it with a brush. DO NOT wash it with water.
- ◆ Be careful of the sharp metal burrs. Keep kids from using it.
- ◆ Keep it in a cool and dry place.
- ◆ It's not recommended that customers disassemble or replace any part of it.
- ◆ If you have any special requirement, kindly operate with the advice from related professional persons.

## Troubleshooting

- ◆ Q: Why is the coarseness obviously uneven suddenly?

A: First, make sure the top lid above the bearing tight. If it's loose, try to rotate it anti-clockwise till it's tight. If it's not solved, contact us for more help.

- ◆ Q: Why is the scale of the adjuster too loose to adjust the coarseness?

A: Because the spring or the burrs get stuck. Try to hold the body and shake the handle slightly till you hear a click, which means the spring or burrs are loose. If not, try to unscrew the lid above the bearing and take the whole burr set out. Clean the burr sets and install them.

We won't take responsibility if customers are against these notifications above.

\* The design of vertical strips version is supported by MQ coffee.

chestnut

泰摩栗子SILM咖啡豆研磨器

TIMEMORE CHESTNUT SILM COFFEE GRINDER

TIMEMORE Coffee specializes in original  
specialty coffee equipment.

With Philosophy of Profession and Aesthetics

Create valuable coffee equipment

Let's enjoy slow living with more time

#### CONTACT

---

✉ [info@timemore.com](mailto:info@timemore.com)

[www.timemore.com](http://www.timemore.com)



@TIMEMORECOFFEE